

MAZSxxxG Series

Silicon planar type

For constant voltage, constant current, waveform clipper and surge absorption circuit

■ Features

- Low noise type
- V_Z rank classified ($V_Z = 2.4\text{ V to }39\text{ V}$)

■ Absolute Maximum Ratings $T_a = 25^\circ\text{C}$

Parameter	Symbol	Rating	Unit
Repetitive peak forward current	I_{FRM}	200	mA
Total power dissipation *	P_{tot}	150	mW
Junction temperature	T_j	150	$^\circ\text{C}$
Storage temperature	T_{stg}	-55 to +150	$^\circ\text{C}$

Note) *: With a printed circuit board

■ Package

- Code
SSMini2-F4
- Pin Name
1: Anode
2: Cathode

■ Marking Symbol

Refer to the list of the electrical characteristics within part numbers

■ Internal Connection

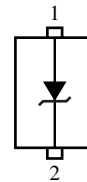

■ Common Electrical Characteristics $T_a = 25^\circ\text{C} \pm 3^\circ\text{C}$ *1

Parameter	Symbol	Conditions	Min	Typ	Max	Unit
Forward voltage	V_F	$I_F = 10\text{ mA}$		0.9	1.0	V
Zener voltage *2	V_Z	I_Z Specified value				V
Reverse current	I_R	V_R Specified value				μA
Zener rise operating resistance	R_{ZK}	I_Z Specified value				Ω
Zener operating resistance	R_Z	I_Z Specified value				Ω
Temperature coefficient of zener voltage *3	S_Z	I_Z Specified value				$\text{mV}/^\circ\text{C}$

Note) 1. Measuring methods are based on JAPANESE INDUSTRIAL STANDARD JIS C 7031 measuring methods for diodes.

2. Rated input/output frequency: 5 MHz

3. *1: The V_Z value is for the temperature of 25°C . In other cases, carry out the temperature compensation.

*2: Guaranteed at 20 ms after power application.

*3: $T_j = 25^\circ\text{C}$ to 150°C

■ Electrical characteristics within part numbers $T_a = 25^\circ\text{C} \pm 3^\circ\text{C}$

Part Number	Zener voltage				Reverse current		Zener operating resistance				Temperature coefficient of zener voltage		Marking symbol
	V _Z (V)			I _Z (mA)	I _R (μA)	V _R (V)	R _Z (Ω)		R _{ZK} (Ω)		S _Z (mV/°C)	I _Z (mA)	
	Min	Nom	Max				Max	I _Z (mA)	Max	I _Z (mA)			
MAZS024G0L	2.28	2.40	2.60	5	120	1.0	100	5	—	—	-1.6	5	T
MAZS027G0L	2.50	2.70	2.90				2 or 2 ₋ or 2 [^]						
MAZS027GLL	2.50	2.60	2.75				2 ₋						
MAZS027GHL	2.65	2.80	2.90				2 [^]						
MAZS030G0L	2.80	3.00	3.20	5	50	1.0	120	5	—	—	-2.1	5	3 or 3 ₋ or 3 [^]
MAZS030GLL	2.80	2.90	3.05				3 ₋						
MAZS030GHL	2.95	3.10	3.20				3 [^]						
MAZS033G0L	3.10	3.30	3.50				F or F ₋ or F [^]						
MAZS033GLL	3.10	3.20	3.35	5	20	1.0	130	5	—	—	-2.4	5	F ₋
MAZS033GHL	3.25	3.40	3.50				F [^]						
MAZS036G0L	3.40	3.60	3.80				H or H ₋ or H [^]						
MAZS036GLL	3.40	3.50	3.65				H ₋						
MAZS036GHL	3.55	3.70	3.80	H [^]									
MAZS039G0L	3.70	3.90	4.10	5	10	1.0	130	5	—	—	-2.5	5	K or K ₋ or K [^]
MAZS039GLL	3.70	3.80	3.97				K ₋						
MAZS039GHL	3.87	4.00	4.10				K [^]						
MAZS043G0L	4.00	4.30	4.60				L or L ₋ or L ₋ or L [^]						
MAZS043GLL	4.03	4.10	4.26	5	10	1.0	130	5	—	—	-2.5	5	L ₋
MAZS043GML	4.17	4.30	4.40				L ₋						
MAZS043GHL	4.31	4.40	4.54				L [^]						
MAZS047G0L	4.40	4.70	5.00				N or N ₋ or N ₋ or N [^]						
MAZS047GLL	4.45	4.60	4.69	5	2.0	1.0	80	5	800	1.0	-1.4	5	N ₋
MAZS047GML	4.59	4.70	4.83				N ₋						
MAZS047GHL	4.74	4.90	4.99				N [^]						
MAZS051G0L	4.80	5.10	5.40				5 or 5 ₋ or 5 ₋ or 5 [^]						
MAZS051GLL	4.87	5.00	5.12	5	1.0	2.0	60	5	500	1.0	-0.8	5	5 ₋
MAZS051GML	5.00	5.10	5.26				5 ₋						
MAZS051GHL	5.14	5.30	5.40				5 [^]						
MAZS056G0L	5.30	5.60	6.00				P or P ₋ or P ₋ or P [^]						
MAZS056GLL	5.30	5.40	5.58	5	0.5	2.5	40	5	200	0.5	1.2	5	P ₋
MAZS056GML	5.48	5.60	5.76				P ₋						
MAZS056GHL	5.66	5.80	5.95				P [^]						
MAZS062G0L	5.80	6.20	6.60				6 or 6 ₋ or 6 ₋ or 6 [^]						
MAZS062GLL	5.85	6.00	6.15	5	0.2	4.0	30	5	100	0.5	2.3	5	6 ₋
MAZS062GML	6.05	6.20	6.36				6 ₋						
MAZS062GHL	6.24	6.40	6.56				6 [^]						
MAZS068G0L	6.40	6.80	7.20				R or R ₋ or R ₋ or R [^]						
MAZS068GLL	6.44	6.60	6.77	5	0.1	4.0	20	5	60	0.5	3.0	5	R ₋
MAZS068GML	6.64	6.80	6.98				R ₋						
MAZS068GHL	6.85	7.00	7.20				R [^]						
MAZS075G0L	7.00	7.50	7.90				7 or 7 ₋ or 7 ₋ or 7 [^]						
MAZS075GLL	7.07	7.30	7.43	5	0.1	5.0	20	5	60	0.5	4.0	5	7 ₋
MAZS075GML	7.29	7.50	7.67				7 ₋						
MAZS075GHL	7.51	7.70	7.89				7 [^]						
MAZS082G0L	7.70	8.20	8.70				8 or 8 ₋ or 8 ₋ or 8 [^]						
MAZS082GLL	7.77	7.90	8.17	5	0.1	5.0	20	5	60	0.5	4.6	5	8 ₋
MAZS082GML	8.03	8.20	8.43				8 ₋						
MAZS082GHL	8.29	8.50	8.70				8 [^]						
MAZS091G0L	8.50	9.10	9.60				9 or 9 ₋ or 9 ₋ or 9 [^]						
MAZS091GLL	8.58	8.80	9.02	5	0.1	6.0	20	5	60	0.5	5.5	5	9 ₋
MAZS091GML	8.87	9.10	9.33				9 ₋						
MAZS091GHL	9.14	9.40	9.60				9 [^]						

■ Electrical characteristics within part numbers (continued) $T_a = 25^\circ\text{C} \pm 3^\circ\text{C}$

Part Number	Zener voltage			I_Z (mA)	Reverse current		Zener operating resistance				Temperature coefficient of zener voltage		Marking symbol
	V_Z (V)				I_R (μA)	V_R (V)	R_Z (Ω)		R_{ZK} (Ω)		S_Z (mV/ $^\circ\text{C}$)	S_Z (mV/ $^\circ\text{C}$)	
	Min	Nom	Max				Max	I_Z (mA)	Max	I_Z (mA)			
MAZS100G0L	9.40	10.00	10.60	5	0.05	7.0	30	5	60	0.5	6.4	5	10 or 10_ or 10- or 10^
MAZS100GLL	9.44	9.70	9.92										10_
MAZS100GML	9.75	10.00	10.25										10-
MAZS100GHL	10.07	10.30	10.59										10^
MAZS110G0L	10.40	11.00	11.60	5	0.05	8.0	30	5	60	0.5	7.4	5	11 or 11_ or 11- or 11^
MAZS110GLL	10.40	10.70	10.94										11_
MAZS110GML	10.73	11.00	11.28										11-
MAZS110GHL	11.05	11.30	11.60										11^
MAZS120G0L	11.40	12.00	12.70	5	0.05	9.0	30	5	80	0.5	8.4	5	12 or 12_ or 12- or 12^
MAZS120GLL	11.40	11.70	11.96										12_
MAZS120GML	11.73	12.00	12.33										12-
MAZS120GHL	12.06	12.30	12.68										12^
MAZS130G0L	12.40	13.00	14.10	5	0.05	10.0	35	5	80	0.5	9.4	5	13 or 13_ or 13- or 13^
MAZS130GLL	12.40	12.70	12.99										13_
MAZS130GML	12.73	13.00	13.40										13-
MAZS130GHL	13.25	13.70	14.08										13^
MAZS150G0L	13.90	15.00	15.60	5	0.05	11.0	40	5	80	0.5	11.4	5	15 or 15_ or 15- or 15^
MAZS150GLL	13.90	14.30	14.76										15_
MAZS150GML	14.60	15.00	15.35										15-
MAZS150GHL	14.95	15.30	15.60										15^
MAZS160G0L	15.30	16.00	17.10	5	0.05	12.0	50	5	80	0.5	12.4	5	16 or 16_ or 16- or 16^
MAZS160GLL	15.30	15.70	16.09										16_
MAZS160GML	15.70	16.00	16.50										16-
MAZS160GHL	16.26	16.70	17.10										16^
MAZS180G0L	16.90	18.00	19.10	5	0.05	13.0	60	5	80	0.5	14.4	5	18 or 18_ or 18- or 18^
MAZS180GLL	16.90	17.30	17.76										18_
MAZS180GML	17.55	18.00	18.45										18-
MAZS180GHL	18.20	18.70	19.10										18^
MAZS200G0L	18.80	20.00	21.20	5	0.05	15.0	80	5	100	0.5	16.4	5	20 or 20_ or 20- or 20^
MAZS200GLL	18.85	19.30	19.81										20_
MAZS200GML	19.50	20.00	20.50										20-
MAZS200GHL	20.15	20.70	21.19										20^
MAZS220G0L	20.80	22.00	23.30	5	0.05	17.0	80	5	100	0.5	18.4	5	22 or 22_ or 22- or 22^
MAZS220GLL	20.80	21.30	21.86										22_
MAZS220GML	21.45	22.00	22.55										22-
MAZS220GHL	22.10	22.70	23.24										22^
MAZS240G0L	22.80	24.00	25.60	5	0.05	19.0	100	5	120	0.5	20.4	5	24 or 24_ or 24- or 24^
MAZS240GLL	22.80	23.30	23.97										24_
MAZS240GML	23.50	24.00	24.70										24-
MAZS240GHL	24.35	25.00	25.60										24^
MAZS270G0L	25.10	27.00	28.90	2	0.05	21.0	120	2	120	0.5	23.4	2	27 or 27_ or 27- or 27^
MAZS270GLL	25.30	26.00	26.70										27_
MAZS270GML	26.30	27.00	27.70										27-
MAZS270GHL	27.30	28.00	28.70										27^
MAZS300G0L	28.00	30.00	32.00	2	0.05	23.0	160	2	160	0.5	26.6	2	30 or 30_ or 30- or 30^
MAZS300GLL	28.30	29.00	29.70										30_
MAZS300GML	29.30	30.00	30.80										30-
MAZS300GHL	30.20	31.00	31.80										30^
MAZS330G0L	31.00	33.00	35.00	2	0.05	25.0	200	2	200	0.5	29.7	2	33 or 33_ or 33- or 33^
MAZS330GLL	31.20	32.00	32.80										33_
MAZS330GML	32.20	33.00	33.80										33-
MAZS330GHL	33.20	34.00	34.90										33^

■ Electrical characteristics within part numbers (continued) $T_a = 25^\circ\text{C} \pm 3^\circ\text{C}$

Part Number	Zener voltage V_Z (V)				Reverse current I_R (μA)		Zener operating resistance				Temperature coefficient of zener voltage S_Z (mV/ $^\circ\text{C}$)		Marking symbol
	Min	Nom	Max	I_Z (mA)	Max	V_R (V)	R_Z (Ω)		R_{ZK} (Ω)		Typ	I_Z (mA)	
							Max	I_Z (mA)	Max	I_Z (mA)			
MAZS360G0L	34.00	36.00	38.00	2	0.05	27.0	250	2	250	0.5	33.0	2	36 or 36_ or 36- or 36^
MAZS360GLL	34.10	35.00	35.90										36_
MAZS360GML	35.10	36.00	36.90										36-
MAZS360GHL	36.10	37.00	37.90										36^
MAZS390G0L	37.00	39.00	41.00	2	0.05	30.0	300	2	300	0.5	35.6	2	39 or 39_ or 39- or 39^
MAZS390GLL	37.10	38.00	39.00										39_
MAZS390GML	38.00	39.00	40.00										39-
MAZS390GHL	39.00	40.00	41.00										39^

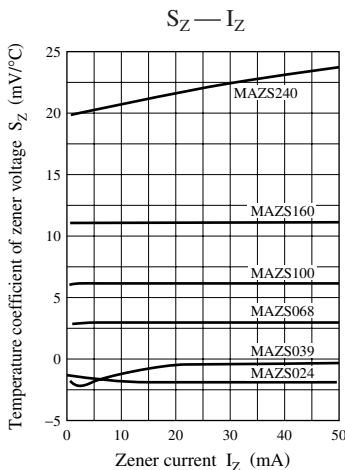
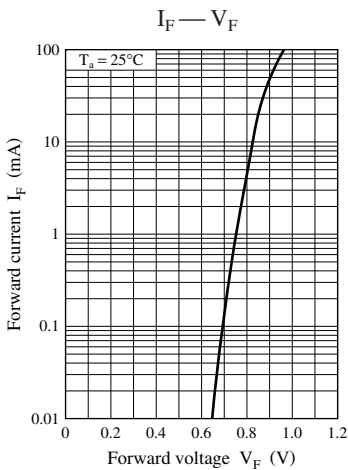
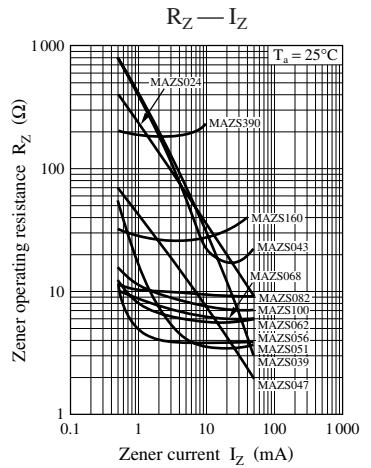
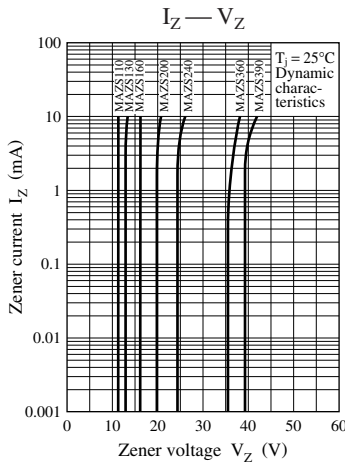
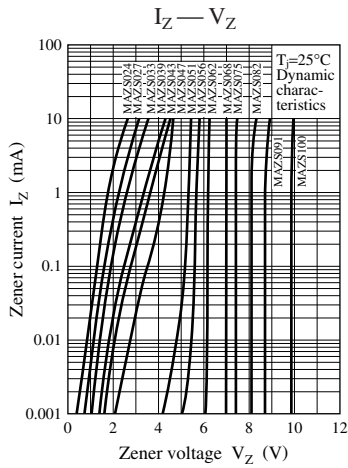
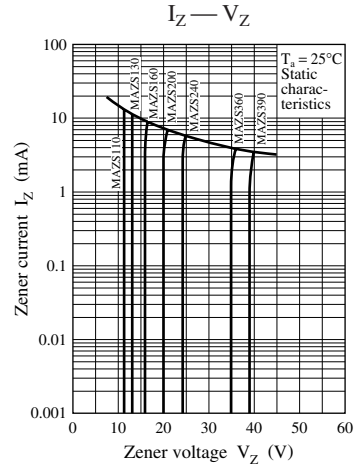
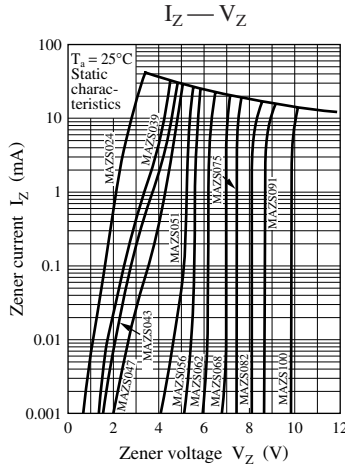
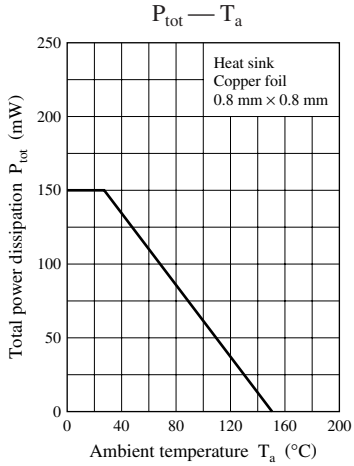

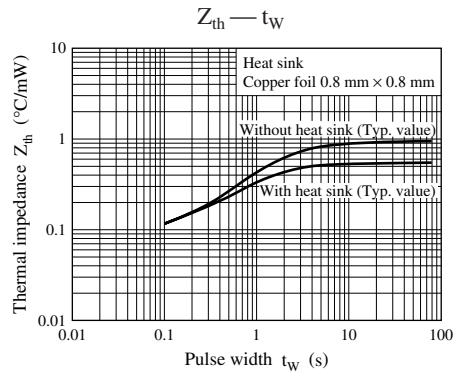
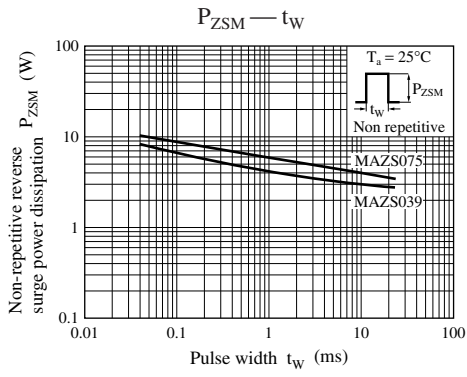

SSMini2-F4

Unit: mm

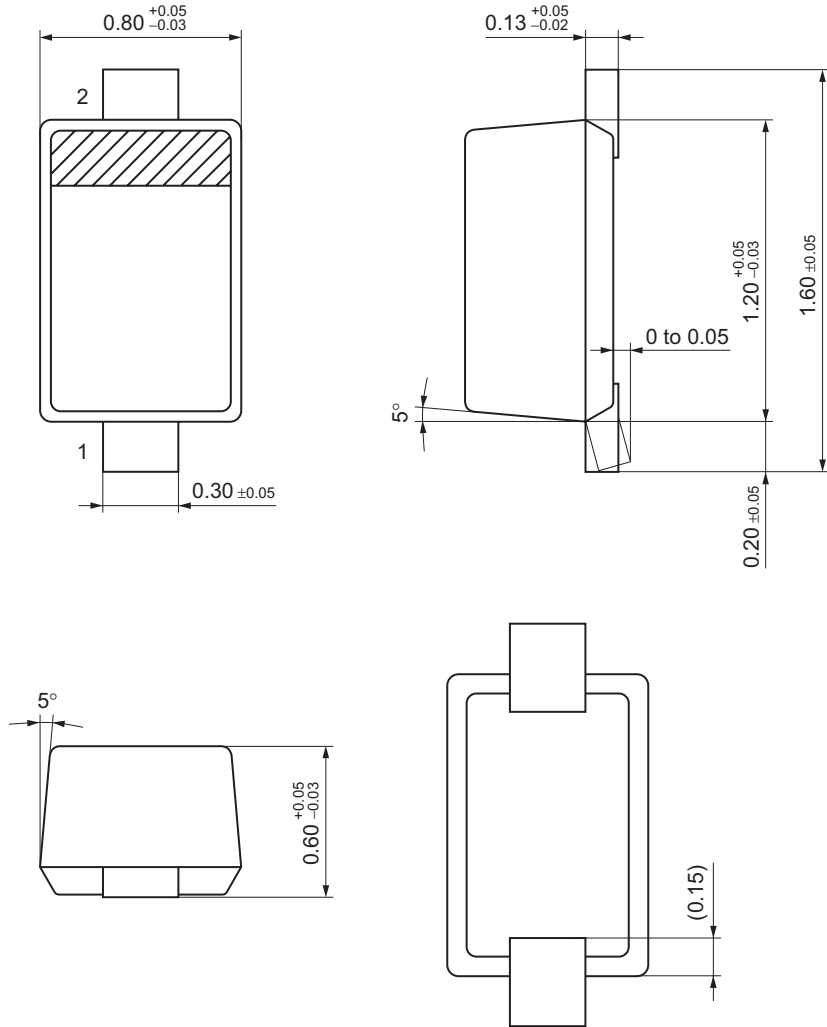

Request for your special attention and precautions in using the technical information and semiconductors described in this book

- (1) If any of the products or technical information described in this book is to be exported or provided to non-residents, the laws and regulations of the exporting country, especially, those with regard to security export control, must be observed.
- (2) The technical information described in this book is intended only to show the main characteristics and application circuit examples of the products, and no license is granted under any intellectual property right or other right owned by our company or any other company. Therefore, no responsibility is assumed by our company as to the infringement upon any such right owned by any other company which may arise as a result of the use of technical information described in this book.
- (3) The products described in this book are intended to be used for standard applications or general electronic equipment (such as office equipment, communications equipment, measuring instruments and household appliances).
Consult our sales staff in advance for information on the following applications:
 - Special applications (such as for airplanes, aerospace, automobiles, traffic control equipment, combustion equipment, life support systems and safety devices) in which exceptional quality and reliability are required, or if the failure or malfunction of the products may directly jeopardize life or harm the human body.
 - Any applications other than the standard applications intended.
- (4) The products and product specifications described in this book are subject to change without notice for modification and/or improvement. At the final stage of your design, purchasing, or use of the products, therefore, ask for the most up-to-date Product Standards in advance to make sure that the latest specifications satisfy your requirements.
- (5) When designing your equipment, comply with the range of absolute maximum rating and the guaranteed operating conditions (operating power supply voltage and operating environment etc.). Especially, please be careful not to exceed the range of absolute maximum rating on the transient state, such as power-on, power-off and mode-switching. Otherwise, we will not be liable for any defect which may arise later in your equipment.
 - Even when the products are used within the guaranteed values, take into the consideration of incidence of break down and failure mode, possible to occur to semiconductor products. Measures on the systems such as redundant design, arresting the spread of fire or preventing glitch are recommended in order to prevent physical injury, fire, social damages, for example, by using the products.
- (6) Comply with the instructions for use in order to prevent breakdown and characteristics change due to external factors (ESD, EOS, thermal stress and mechanical stress) at the time of handling, mounting or at customer's process. When using products for which damp-proof packing is required, satisfy the conditions, such as shelf life and the elapsed time since first opening the packages.
- (7) This book may be not reprinted or reproduced whether wholly or partially, without the prior written permission of Matsushita Electric Industrial Co., Ltd.